

CPS LED LIGHTING

Applications:

Stadiums

School Playgrounds

Entertainment Plaza

Parking Lots



150W Shoebox Light

The shoe box lights are built to be extremely versatile with installation. This is due to the varying selection of mounts available.

The light is also easy to operate, with bright, consistent lighting to make it effective in large areas.

ORDER INFORMATION

SERIES	WATTAGE (W)	VOLTAGE UH=200-480V	COLOR BR=BROWN	VIEWING ANGLE	KELVIN 50=5000K
CBS-SBX-	150W	UH	BR	T3	40
					50
EXAMPLE: CPS-SBX-150W-UH-BR-T3-50					
UL PART # CPS-SBX-150W-UH-BR-T3-50					
A&D Mount comes standard with all shoebox units. Please specify if different mounting option is needed. Other options include: Yoke mount (YM), Adjustable mount (AM), and Direct mount (DM).					

SPECIFICATIONS

UL, CUL Certificate
 IP65 internal driver, input voltage 200-480 VAC
 No UV or IR in the beam
 Easy to install and operate
 Long lifespan
 Light is soft and uniform, safe on eyes
 Instant start, no flickering, no humming
 Green and eco-friendly, without mercury



CPS LED LIGHTING

843-407-6803

SALES@CPSLED.COM

WWW.CPSLED.COM

CPS LED LIGHTING

TECHNICAL CHARACTERISTICS

Color temperature	4000K, 5000K
Input voltage	200-480V 50-60Hz
Lumens	18800-21000 LM
Lumen Efficiency	125-140 LM/W
Waterproof rating	IP65
CRI	>70
PFC	>0.9
Viewing angle	150°x85°T3
Operating temperature	-40°F to 104°F
Operating humidity	20%-90% RH
Storage temperature	86°F to 176°F
Storage humidity	10%-95%
L70 life	Projected 100,000 hours
Warranty	10 years

MATERIALS

Housing	Aluminum
Housing color	Brown (Standard)

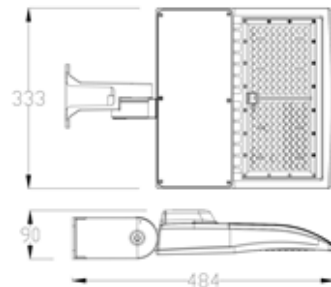

AM

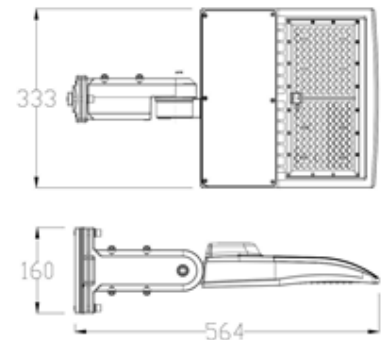
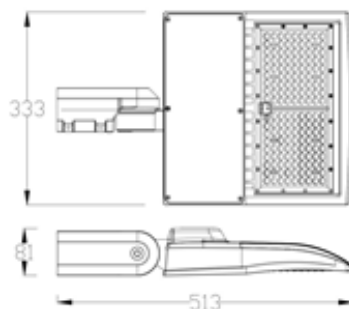

DM

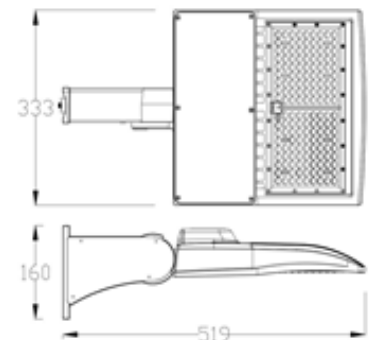

CPS LED LIGHTING

843-407-6803

SALES@CPSLED.COM

WWW.CPSLED.COM

CPS LED LIGHTING

Luminaire Property

Luminaire Manufacturer:
Voltage: 199.5 V
Power: 152.47 W

Current: 0.7751 A
Power Factor: 0.9836

Photometric Results

IES Classification: Type III
Total Rated Lamp Lumens: 19179.2 lm
Efficiency: 100%
Upward Ratio: 0%
Central Intensity: 4647.29 cd
Pos of Max. Intensity: H22.5 V69

Longitudinal Classification: Medium
Measurement Flux: 19179.2 lm
Downward Ratio: 100%
Luminaire Efficacy Rating (LER): 125.79
Max. Intensity: 6975.57 cd

Luminous Intensity Distribution Curve

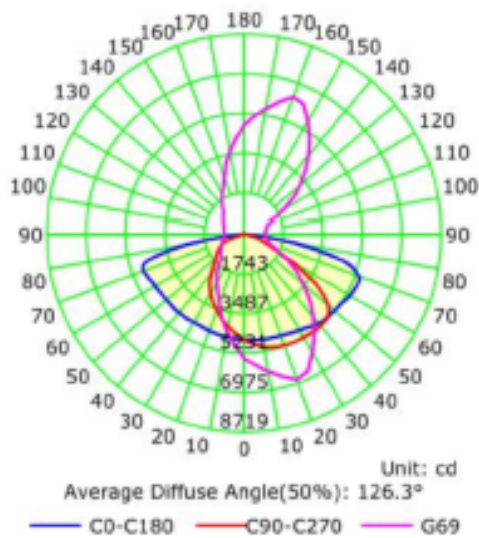

The Average Illuminance Effective Figure

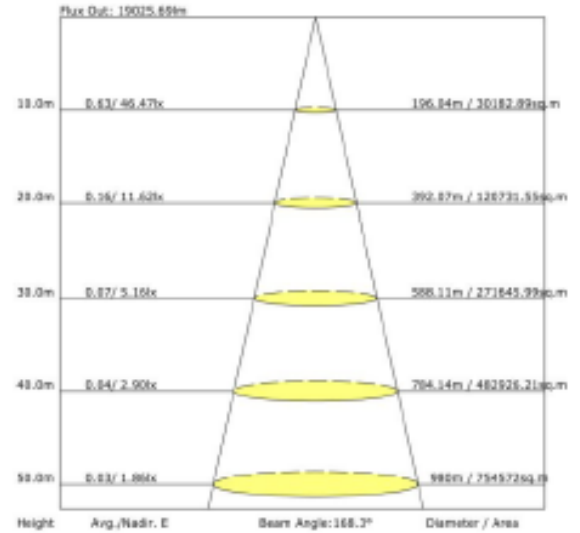

PACKAGING INFORMATION

STENT TYPE	LAMP NET WEIGHT	SIZE (Inches)	QTY/CARTON	GROSS WEIGHT/CARTON
AM	12.56	23.03*15.15*6.29	1 PC	11.905
DM	13.62	23.03*15.15*6.29	1 PC	13
YM	11.9	23.03*15.15*6.29	1 PC	11.24
A&D	14.3	23.03*15.15*6.29	1 PC	13.89

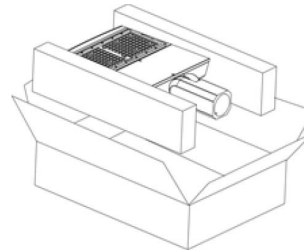

CPS LED LIGHTING
843-407-6803
SALES@CPSLED.COM
WWW.CPSLED.COM

NOTICE FOR USER

Please turn off power before installing or changing assembly parts.
The input voltage and lamps should be matched, after connecting the power line.
Please make sure the wiring section is insulated.